

Symaro™

## Room sensors

## QFA41...

for relative humidity and temperature  
with calibration certificates

- Operating voltage AC 24 V / DC 13.5...35 V
- Signal output DC 0...10 V / 4...20 mA for relative humidity and temperature
- Very high measuring accuracy across the entire measuring range
- Capacitive humidity measurement
- Recalibration service
- Test function for loop test
- Range of use  $-40...+70$  °C / 0...100 % r. h.  
with LCD display  $-25...+70$  °C / 0...100 % r. h.

### Use

The QFA41... sensor is used in ventilation and air conditioning plants requiring:

- Very high accuracy and reliability for measuring relative humidity and temperature
- Regular recalibration and readjustment of the sensors

Examples:

- Storage and production facilities in the paper, textiles, pharmaceutical, chemical, electronics industries, etc.
- Laboratories
- Hospitals
- Computer centers
- Greenhouses

## Type summary

Type reference	Temperature measuring range	Temperature signal output	Humidity measuring range	Humidity signal output	Operating voltage	Measured value display
<b>QFA4160</b>	0...50 °C / -40...+70 °C / -35...+35 °C	active, DC 0...10 V	0...100 %	active, DC 0...10 V	AC 24 V or DC 13,5...35 V	No
<b>QFA4160D</b>	0...50 °C / -40...+70 °C / -35...+35 °C	active, DC 0...10 V	0...100 %	active, DC 0...10 V	AC 24 V or DC 13,5...35 V	Yes
<b>QFA4171</b>	0...50 °C / -40...+70 °C / -35...+35 °C	active, 4...20 mA	0...100 %	active, 4...20 mA	DC 13,5...35 V	No
<b>QFA4171D</b>	0...50 °C / -40...+70 °C / -35...+35 °C	active, 4...20 mA	0...100 %	active, 4...20 mA	DC 13,5...35 V	Yes

## Ordering and delivery

When ordering, please give name and type reference, e.g.:

Room sensor **QFA4160**

Place a separate order for the service set AQF3153 listed under accessories.

The circular connector with its screwed plug is delivered uninstalled.

## Equipment combinations

All systems and devices capable of acquiring and handling the sensor's DC 0...10 V or 4...20 mA output signal.

When using the sensors for minimum or maximum selection, for averaging, or to calculate enthalpy, enthalpy difference, absolute humidity, and dew point, we recommend to use the SEZ220 signal converter (see Data Sheet N5146).

## Technical design

### Relative humidity

The sensor acquires the relative humidity in the room via its capacitive sensing element whose capacitance varies as a function of the relative humidity of the ambient air. An electronic circuit converts the sensor's signal to a continuous DC 0...10 V or 4...20 mA signal, corresponding to a relative humidity of 0...100 %.

### Temperature

The sensor acquires the temperature in the room via its sensing element whose electrical resistance changes as a function of the temperature. This variation is converted to an active DC 0...10 V or 4...20 mA output signal, depending on the type of sensor. The output signal corresponds to a selectable temperature range of 0... 50 °C, -35...+35 °C, or -40...+70 °C.

### Burden diagram

Output signal, terminal I1 / I2

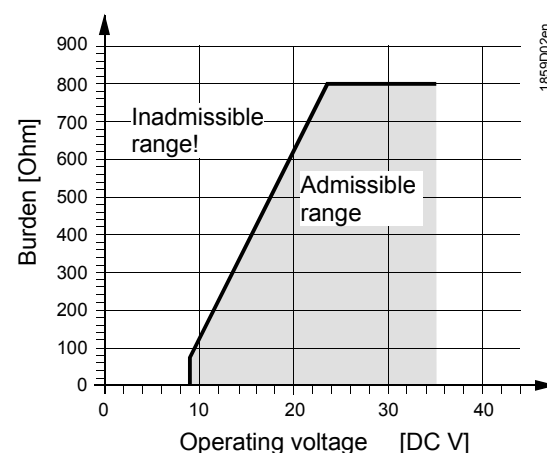

The room sensor consists of a housing, a printed circuit board, connection terminals, a measuring tip and a circular connector. The two-part housing comprises a base and a screwed removable cover.

A rubber seal is installed between base and cover in order to satisfy the requirements of IP 65 degree of protection.

The measuring circuit and the setting element are accommodated on the printed circuit board inside the cover, the connection terminals on the base. Housing and measuring tip are screwed together. The measuring tip features a degree of protection of IP40. The sensing elements are located at the end of the measuring tip, protected by a screw-on filter cap.

Cable entry is made via the circular connector, which consists of coupling piece with M16 thread and connector with screwed plug. The coupling piece is secured to the housing and internally wired.

The sensor is designed for wall mounting.

**Measured value display**

The types **QFA4160D** and **QFA4171D** provide the measured values on its LCD display. The following measured values are displayed alternately in intervals of 5 s:

- Temperature: in °C or °F
- Humidity: in % r. h.

**Setting elements**

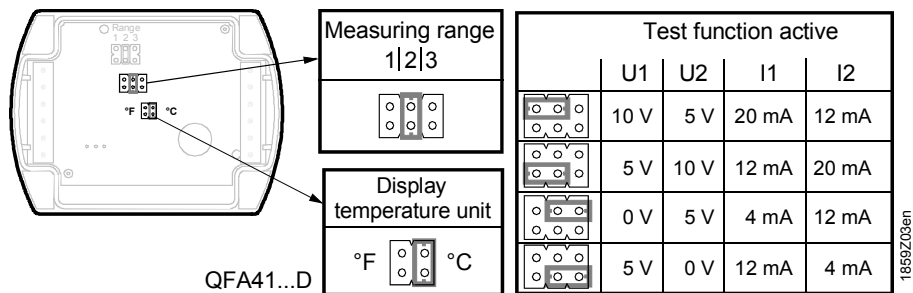

The setting elements are located inside the cover. A setting element consists of 6 pins and a jumper. It is used for selecting the required temperature measuring range and for activating the test function. Types with LCD display have a second setting element with 4 pins and a jumper.

The different jumper positions have the following meaning:

- *For the active temperature measuring range:*
  - Jumper in the left position (R1) = -35...+35 °C,
  - Jumper in the middle position (R2) = 0...50 °C (factory setting)
  - Jumper in the right position (R3) = -40...+70 °C
- *For activating the test function:*
  - Jumper in the horizontal position: The values available at the signal output are those given in the table "Test function active".
- *For the measured value display (QFA41...D)*
  - Jumper vertical in the right position = °C (factory setting)
  - Jumper vertical in the left position = °F

**Malfunction**

- Should the temperature sensor become faulty a voltage of 0 V (4 mA) will be applied at signal output U2 (I2) after 60 seconds, and the humidity signal at signal output U1 (I1) will reach 10 V (20 mA).
- Should the humidity sensor become faulty a voltage of 10 V (20 mA) will be applied at signal output U1 (I1) after 60 seconds, and the temperature signal will remain active.

## Calibration certificates

The sensor and its exchangeable AQF4150 measuring tip are numbered, registered and calibrated prior to delivery. The associated calibration certificates are supplied with the sensor.

## Service set AQF3153

The service set comprises three measuring tips without sensor element. Each tip signals a predefined temperature and humidity value to the basic unit:

- 85 % r. h., 40 °C
- 50 % r. h., 23 °C
- 20 % r. h., 5 °C

The fixed values are available at the signal outputs. The measuring tips can be exchanged in operation.

The service set allows for easy and quick loop test performance as recommended by Vertical Market Pharma and offered by their calibration service in various countries.

## Accessories

<i>Name</i>	<i>Type reference</i>
Measuring tip certified (exchangeable)	<b>AQF4150</b>
Service set (for loop test)	<b>AQF3153</b>
Filter cap (for replacement)	<b>AQF3101</b>
3 m cable for remote measurement	<b>AQY2010</b>

## Engineering notes

A transformer for safety extra low-voltage (SELV) with separate windings for 100 % duty is required to power the sensor. All safety regulations valid at the location of the plant must be complied with when sizing and protecting the transformer. When sizing the transformer, the sensor's power consumption must be taken into consideration.

For the electrical connection of the sensor, refer to the Data Sheets of the devices with which the sensor is used.

The maximum permissible cable lengths must be considered.

## Cable routing and cable selection

It must be considered for routing of cables that electrical interference is the greater, the longer the cables run side by side and the smaller the distance between them. Use shielded cables in environments having EMC problems.

Twisted pairs of cables are required for the secondary supply lines and the signal lines.

## Note to **QFA4171(D)**

Terminals G1(+) and I1(–) for the humidity output must always be connected to power, even if only terminals G2(+) and I2(–) of the temperature output are used!

## Mounting notes

### Mounting location

Inside wall (not on outside wall!) of the room to be air conditioned; not in recesses, behind curtains, above or close to heat sources or shelves, not on walls behind which a chimney is located.

The sensor must not be exposed to spot lights or direct solar radiation.

Install the sensor in the occupied space about 1.5 m above the floor and at least 50 cm from the next wall.

### Caution!

- The seal between base and cover must not be removed, or else degree of protection IP 65 will be no longer ensured.
- The sensing elements inside the measuring tip are sensitive to shock and impact. Avoid any such impact on mounting.

### Mounting position

The QFA4160 must not be mounted with the measuring tip pointing upward.

### Mounting Instructions

Mounting Instructions are printed on the inner side of the package.

## Commissioning notes



Prior to switching on power, check wiring.  
On the sensor, select the required temperature measuring range.  
Wiring and the output signals can be checked by making use of the test function (refer to "Mechanical design").

We recommend not to use voltmeters or ohmmeters directly at the sensing element. In the case of the simulated passive output signals, measurements with commercially available meters cannot be made (measuring current too small).

## Recalibration service

Siemens BT provides a recalibration service for used sensors.  
Recalibration should be performed at 12-month intervals under "normal" conditions, i.e. within the comfort range for humidity and temperature, and at air contamination levels that are not above average.

### Services provided

The recalibration service includes the following:

- Delivery and invoicing of the new AQF4150 measuring tip complete with calibration certificate.
- Delivery of a calibration certificate for the (old) measuring tip returned to Siemens BT, enabling the customer to assess the time of usage of the measuring tip.

## Technical data

Power supply	Operating voltage	AC 24 V $\pm$ 20 % or DC 13.5...35 V
	Frequency	50/60 Hz at AC 24 V
	Power consumption	$\leq$ 1 VA
Cable lengths for the measuring signal	Max. perm. cable lengths	refer to Data Sheet of the device handling the signal
Functional data "Humidity sensor"	Measuring range	0...100 % r. h.
	Measuring accuracy at 23 °C and AC/DC 24 V in 0...100 % r.h.	$\pm$ 2 % r. h.
	Temperature dependency	$\leq$ 0.05 % r.h./°C
	Time constant	< 20 s
	Output signal, linear (terminal U1)	DC 0...10 V $\hat{=}$ 0...100 % r.h., max. $\pm$ 1 mA
	Output signal, linear (terminal I1) Burden	4...20 mA $\hat{=}$ 0...100 % r. h. refer to "Function"
Functional data "Temperature sensor"	Measuring range	0...50 °C (R2 = factory setting), -35...+35 °C (R1), -40...+70 °C (R3)
	Sensing element	Pt 1000
	Measuring accuracy at AC/DC 24 V in 23 °C 15...35 °C -35...+70 °C	$\pm$ <0.5 K $\pm$ 0.6 K $\pm$ 0.8 K
	Time constant	8.5 min. (according to airflow and wall coupling)
	Output signal, linear (terminal U2)	DC 0...10 V $\hat{=}$ 0...50/-35...+35/-40...+70 °C $\pm$ 1 mA max.
	Output signal, linear (terminal I2) Burden	4...20 mA $\hat{=}$ 0...50/-35...+35/-40...+70 °C refer to "Function"
Degree of protection	Housing	IP65 to IEC 60529, measuring tip IP40
	Safety class	III to EN 60 730
Electrical connections	Connector with screwed plug	Lumberg RSC 4/9
	Screw terminals for	0.75 mm <sup>2</sup> max.
	Cable entry	4...8 mm dia.

Environmental conditions	Operation	
	Climatic conditions	Class 4K2 to IEC 60721-3-4
	Temperature (housing with electronics)	-40...+70 °C
	LCD-display readable	-25...+70 °C
	Humidity	0...100 % r. h. (with condensation)
	Mechanical conditions	Class 3M2 to IEC 60721-3-3
Materials and colors	Transport to	IEC 60721-3-2
	Climatic condition	Class 2K3
	Temperature	-40...+70 °C
	Humidity	<95 % r. h.
	Mechanical conditions	Class 2M2
	Base	polycarbonate, RAL 7001 (silver-grey)
	Housing cover	polycarbonate, RAL 7035 (light-grey)
	Measuring tip	polycarbonate, RAL 7001 (silver-grey)
	Filter cap	polycarbonate, RAL 7001 (silver-grey)
		Circular connector
	Connector with screwed plug	Lumberg RSC 4/9
	Contact carrier and body	PA, black
	Knurled nut and contact	CuZn, nickel-plated
	Coupling piece	Lumberg RKFM 4/0.5 M
	Contact carrier	TPU
	Casing and contact	CuZn, nickel-plated
	Sensor (entirely)	silicon-free
	Packaging	corrugated cardboard
Standards and directives	Product standard	
	Automatic electrical controls for household and similar use	EN 60 730-1
	Electromagnetic compatibility	
	Immunity	EN 61 000-6-1
	Emissions	EN 61 000-6-3
	CE conformity to	EMC directive 2004/108/EC
	C-tick conformity (EMC) to	EN 61 000-6-3
UL conformity	UL 873	
Environmental compatibility	Environmental product declaration CE1E1858en provides ISO 14001 (environment) information on environmentally compatible product design ISO 9001 (quality) and assessment (RoHS compliance, composition of substances, packaging, environmental benefit, disposal). SN 36350 (environmental comp. products) RL 2002/95/EC (RoHS)	
Weight	Incl. packaging	
	Without LCD-display	0.196 kg
	With LCD-display	0.221 kg
	AQF3153	0.066 kg
	AQF4150	0.050 kg

## Connection terminals

### QFA4160(D)

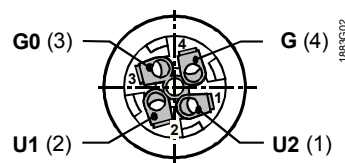
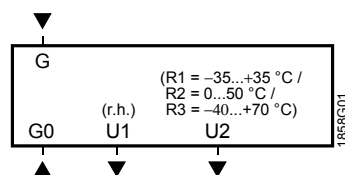

Front view:  
Connector fitted,  
body removed

### QFA4171(D)

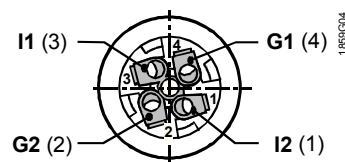
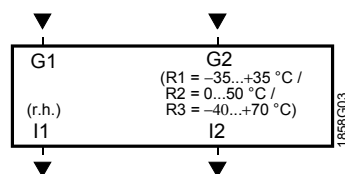

Front view:  
Connector fitted,  
body removed

- G, G0 Operating voltage AC 24 V (SELV) or DC 13.5...35 V
- G1, G2 Operating voltage DC 13.5...35 V
- U1 Signal output DC 0...10 V for relative humidity 0...100 %
- U2 Signal output DC 0...10 V for temperature range 0...50 °C (R2 = factory setting) -35...+35 °C (R1) or -40...+70 °C (R3)
- I1 Signal output 4...20 mA for relative humidity 0...100 %

I2 Signal output 4...20 mA for temperature range 0...50 °C (R2 = factory setting)  
-35...+35 °C (R1) or -40...+70 °C (R3)

**Note on connection terminals of the QFA4171(D):**

Terminals G1(+) and I1(-) for the humidity output must always be connected to power, even if only the temperature output G2(+) and I2(-) is used!

## Dimensions

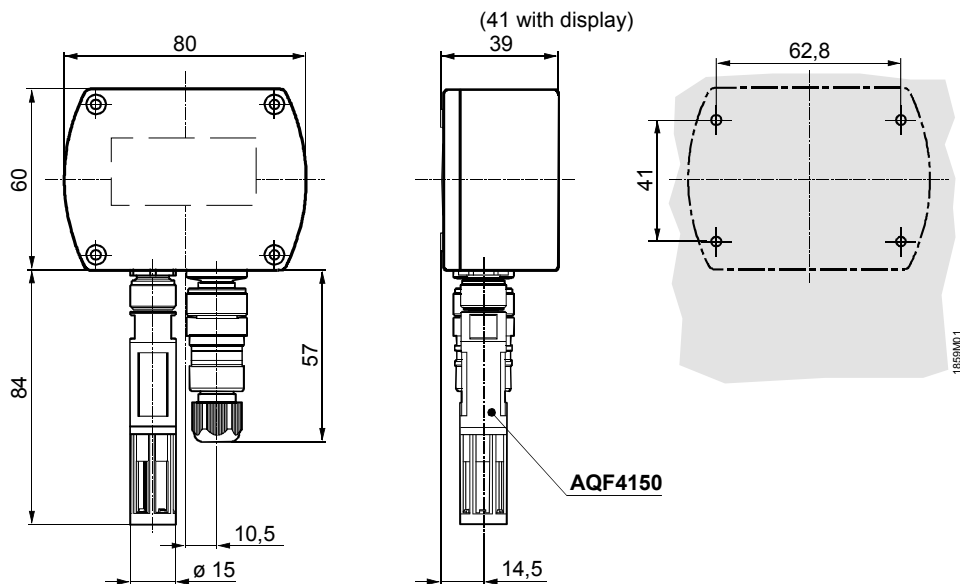

Dimensioning without (with) LCD-display

Dimensions in mm